

Fibreglass Canada

Div. of FRP Manufacturing Inc.

W-1250 UNDERGROUND FIBREGLASS WATER CISTERN

Overall Length: Approx. 3,658 mm (12')

Overall Weight: Approx. 223 kg (490 lbs)

Overall Capacity: Approx. 5,680 L (1,250 Imp Gal, 1,500 US Gal)

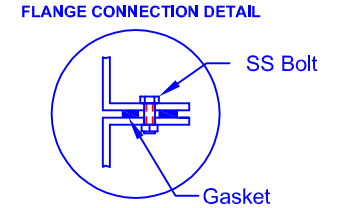
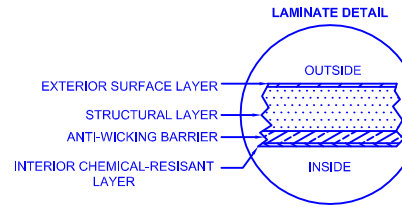

One piece manway is available in 12", 30", 60", and 84" size. Manway attaches directly to tank creating a solid sealed connection.

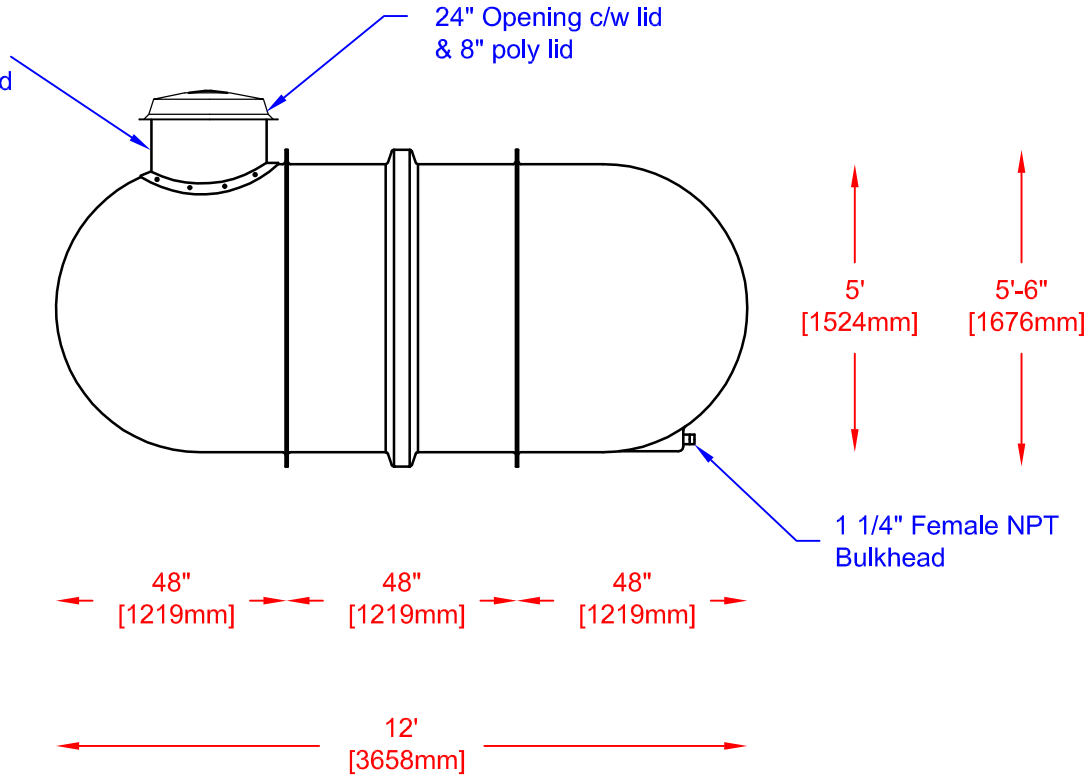

Drinking Water
NSF/ANSI 61

Water cisterns have a gloss interior for purity of water and prevention of bacterial growth.